

ASFLMP

RoHS/RoHS II compliant
Moisture Sensitivity Level- MSL 1
FEATURES:

- Low Power Consumption for high speed communication
- Exceptional Stability Over Temp. at -40 to +85°C, ±15ppm
- Extended Automotive Grade Temp. stability at -55 to +125°C, ±25ppm
- MIL-STD-883 shock and vibration compliant
- Durable QFN Plastic Compact Packaging
- Standby or Disable Tri-state function
- Low jitter (Period jitter RMS and Phase jitter RMS)
- High power supply noise reduction, -50dBc

APPLICATIONS:

- Storage Area Networks (SATA, SAS, Fiber Channel)
- Passive Optical Networks (EPON, 10G-EPON, GPON, 10G-PON)
- Ethernet (1G, 10GBASE-T, KR/LR/SR, FCoE)
- PCI Express
- Display port

STANDARD SPECIFICATIONS:
Key Electrical Specifications – CMOS, LVPECL, LVDS, and HCSL

Parameters	Minimum	Typical	Maximum	Units	Notes	
Frequency Range	CMOS	2.3000*		170.0000	MHz	-20 ~ +70°C -40 ~ +85°C
	CMOS	3.3000*		170.0000		-40 ~ +105°C -55 ~ +125°C
	LVPECL	2.3000*		460.0000		Commercial, Industrial temp. range
	LVDS	2.3000*		460.0000		Commercial, Industrial temp. range
	HCSL	2.3000*		460.0000		Commercial, Industrial temp. range
Operating Temperature	-20		+70	°C	See options	
Storage Temperature	-55		+150	°C		
Overall Frequency Stability	-50		+50	ppm	See options	
Supply Voltage (Vdd)	+2.25		+3.6	V		
Startup Time			5	ms		
Enable Time			20	ns	STD (Tri-state)	
			5	ms	PD option (Power Down)	
Disable Time			5	ns		
Disable Current		20	22	mA	STD (Tri-state)	
			0.095		PD option (Power Down)	
Tri-state Function (Standby/Disable)	"1" (VIH ≥ 0.75*Vdd) or Open: Oscillation "0" (VIL < 0.25*Vdd) : Hi Z			V	40kΩ pull-up resistor embedded	
Aging	-5.0		+5.0	ppm	First year	

* For 2.3000MHz < F0 < 9.9999MHz, 6-8 weeks lead-time applies

Key Electrical Specifications – CMOS

Parameters	Minimum	Typical	Maximum	Units	Notes
Supply Current (I _{dd})		31	35	mA	CL=15pF, 125MHz
Output Logic Level	V _{OH}	0.9*V _{dd}		V	I=±6mA
	V _{OL}		0.1*V _{dd}	V	
Rise Time	Tr	1.1	2.0	ns	CL=15pF
Fall Time	Tf	1.3	2.0	ns	20% to 80%
Duty Cycle		45	55	%	
Integrated Phase Jitter (J _{PH})		0.30	2	ps	200kHz ~ 20MHz@125MHz
		0.38	2		100kHz ~ 20MHz@125MHz
		1.70	2		12kHz ~ 20MHz@125MHz
Period Jitter RMS (J _{PER})		3.0		ps	



Key Electrical Specifications – LVPECL

Parameters		Minimum	Typical	Maximum	Units	Notes
Supply Current (I_{dd})			56.5	58	mA	RL=50Ω
Output Logic Level	V_{OH}	$V_{dd}-1.08$			V	RL=50Ω
	V_{OL}			$V_{dd}-1.55$	V	
Peak to Peak Output Swing (V_{pp})			800		mV	Single ended
Rise Time	T_r		250		ps	RL=50Ω , CL=0pF 20% to 80%
Fall Time	T_f		250			
Duty Cycle		48		52	%	Differential
Integrated Phase Jitter (J_{PH})			0.25	2	ps	200kHz ~ 20MHz @156.25MHz
			0.38	2		100kHz ~ 20MHz @156.25MHz
			1.70	2		12kHz ~ 20MHz @156.25MHz
Period Jitter RMS (J_{PER})			2.5		ps	

Key Electrical Specifications – LVDS

Parameters		Minimum	Typical	Maximum	Units	Notes
Supply Current (I_{dd})			29	32	mA	RL=100Ω
Output Offset Voltage (V_{OS})		1.125		1.4	V	RL=100Ω differential
Delta Offset Voltage (ΔV_{OS})				50	mV	
Peak to Peak Output Swing (V_{pp})			350		mV	Single ended
Rise Time	T_r		200		ps	RL=50Ω , CL=2pF 20% to 80%
Fall Time	T_f		200			
Duty Cycle		48		52	%	Differential
Integrated Phase Jitter (J_{PH})			0.28	2	ps	200kHz ~ 20MHz @156.25MHz
			0.40	2		100kHz ~ 20MHz @156.25MHz
			1.70	2		12kHz ~ 20MHz @156.25MHz
Period Jitter RMS (J_{PER})			2.5		ps	

Key Electrical Specifications – HCSL

Parameters		Minimum	Typical	Maximum	Units	Notes
Supply Current (I_{dd})			40	42	mA	RL=50Ω
Output Logic Level	V_{OH}	0.725			V	RL=50Ω
	V_{OL}			0.1	V	
Peak to Peak Output Swing (V_{pp})			750		mV	Single ended
Rise Time	T_r	200		400	ps	RL=50Ω , CL=2pF 20% to 80%
Fall Time	T_f	200		400		
Duty Cycle		48		52	%	Differential
Integrated Phase Jitter (J_{PH})			0.25	2	ps	200kHz ~ 20MHz @156.25MHz
			0.37	2		100kHz ~ 20MHz @156.25MHz
			1.70	2		12kHz ~ 20MHz @156.25MHz
Period Jitter RMS (J_{PER})			2.5		ps	



Absolute Maximum Ratings

Item	Minimum	Maximum	Unit	Condition
Supply Voltage	-0.3	+4.0	V	
Input Voltage	-0.3	V _{dd} +0.3	V	
Junction Temp.		+150	°C	
Storage Temp.	-55	+150	°C	
Soldering Temp.		+260	°C	40sec max
ESD			V	
HBM		4,000		
MM		400		
CDM		1,500		

OPTIONS AND PART IDENTIFICATION: (Left Blank if Standard)

Programmed Orders (Quantity > 1,000pcs)

ASFLMP [] - [] MHz - [] [] - [] - []

Output Type	Frequency in MHz	Operating Temp.	Overall Freq. Stability	Tri-state (Pin 1)	Packaging
C: CMOS	e.g. 156.2500 MHz (Maximum 4 digits after decimal)	Blank: -20°C ~ +70°C	Blank: ±50ppm	Blank: Tri-state	Blank***: Tube (72pcs / Tube)
LP: LVPECL		L: -40°C ~ +85°C	Y: ±10ppm*	PD: Power Down	T: Tape & Reel (1kpcs / reel)
LV: LVDS		X: -40°C ~ +105°C	R: ±25 ppm		T3: Tape & Reel (3kpcs / reel)
HC: HCSL		Z** : -55°C ~ +125°C			

* Temp option L, X or -20°C ~ +70°C, only

** CMOS output only

*** For Quick turn-around programmable orders < 1000pcs: Due to the immediate availability of stock and the qty of the order, the parts may be delivered as BULK: Cut Tape, Loose parts in Antistatic Bag or in Tube(s). The MOQ per the series will still apply for Tube packaging.

Un-Programmed Orders

Blank un-programmed oscillators are available for quick turn engineering requirements. Please call ABRACON for more information.

ASFLMP [] - BLANK - [] [] - [] - []

Output Type	Operating Temp.	Overall Freq. Stability	Tri-state (Pin 1)	Packaging
C: CMOS	Blank: -20°C ~ +70°C	Blank: ±50ppm	Blank: Tri-state	Blank: Tube (72pcs / Tube)
LP: LVPECL	L: -40°C ~ +85°C	Y: ±10ppm*	PD: Power Down	T: Tape & Reel (1kpcs / reel)
LV: LVDS	X: -40°C ~ +105°C	R: ±25 ppm		T3: Tape & Reel (3kpcs / reel)
HC: HCSL	Z** : -55°C ~ +125°C			

* Temp option L, X or -20°C ~ +70°C, only

** CMOS output only



NOMINAL PERFORMANCE PARAMETERS

(Unless specified otherwise: T=25° C, VDD=3.3 V)

CMOS OUTPUT

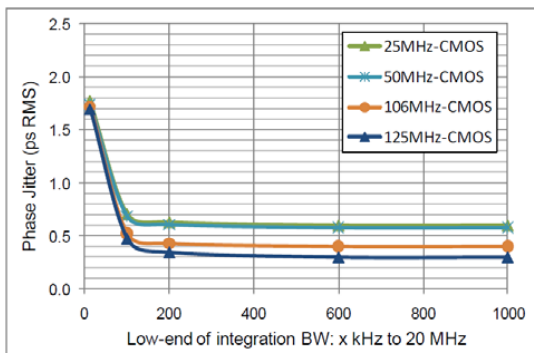

Phase jitter (integrated phase noise)

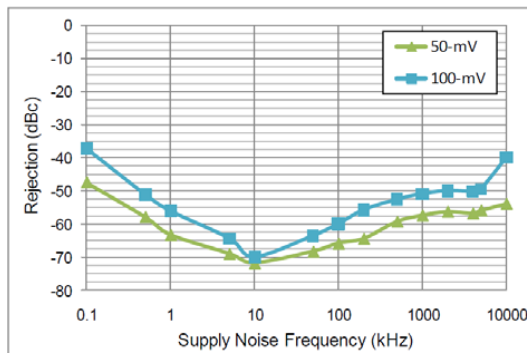

Power supply rejection ratio

Test Circuit

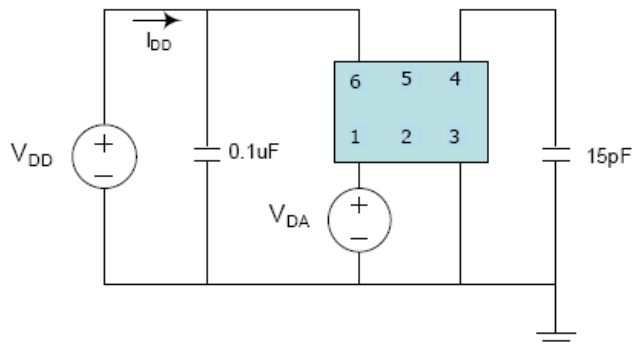

LVPECL output

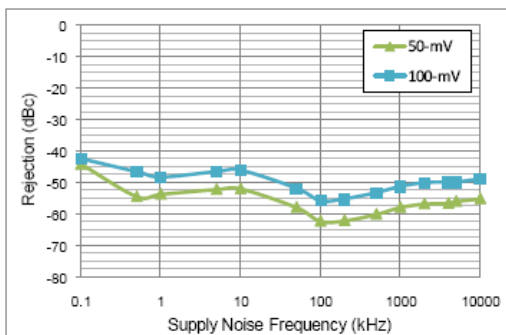

Power supply rejection ratio

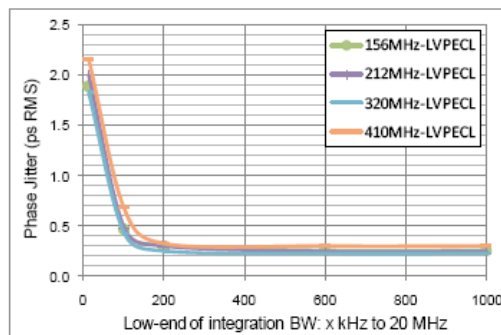

Phase jitter (integrated phase noise)

Test Circuit

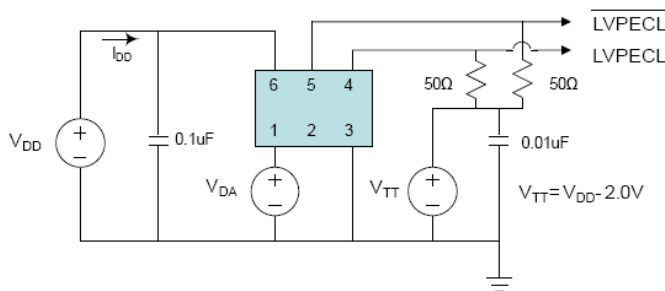



LVDS output

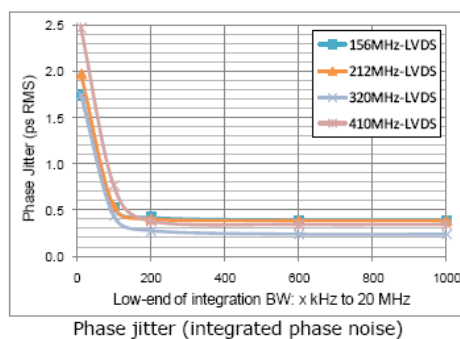
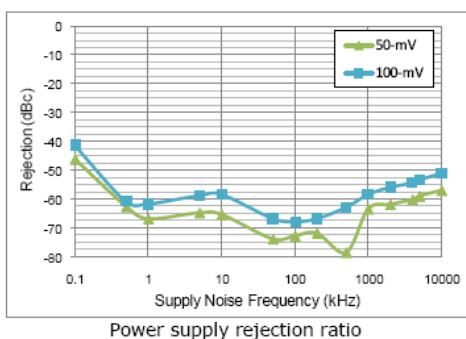

Test Circuit

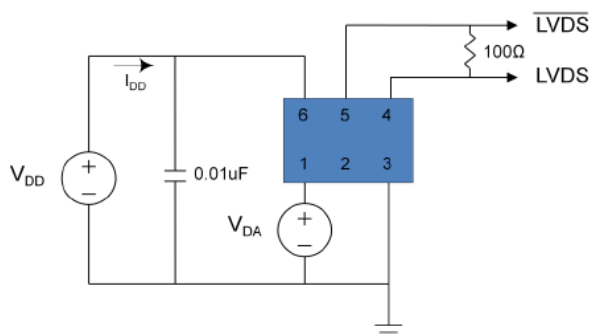

HCSL output

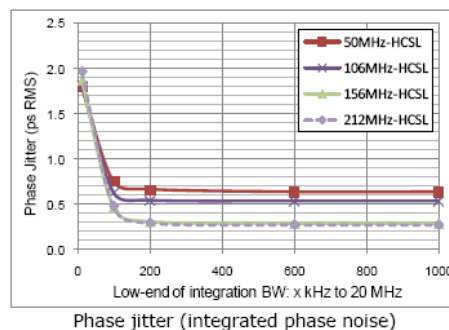
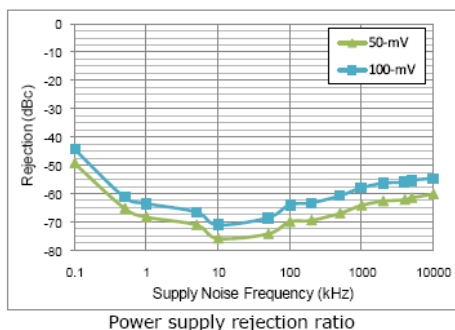

Test Circuit

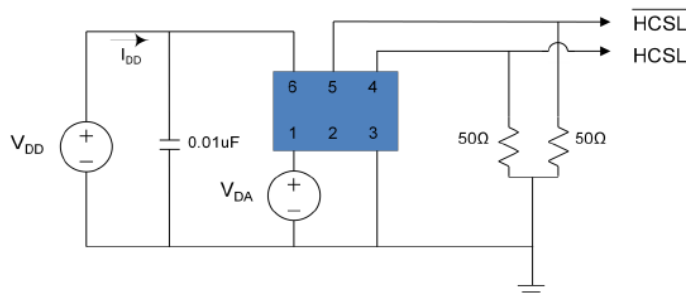

MEMS CLOCK OSCILLATOR

ASFLMP



ASFLMP



RoHS/RoHS II compliant

Life Size



5.0 x 3.2 x 0.85 mm

OUTLINE DIMENSIONS:

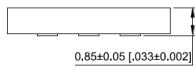
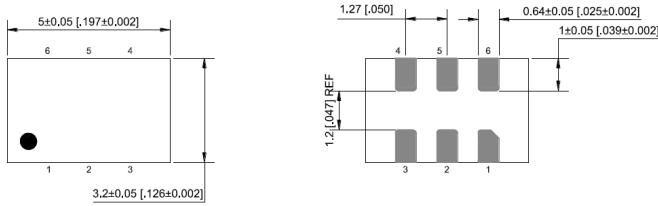

Pin #	Function
1	Tri-state
2	NC
3	GND
4	Output
5	NC (CMOS)
6	Output (LVPECL, LVDS, HCSL) Vdd

Note: Recommend using an approximately 0.01uF bypass capacitor between PIN 6 and 3.

Dimensions: mm (inches)

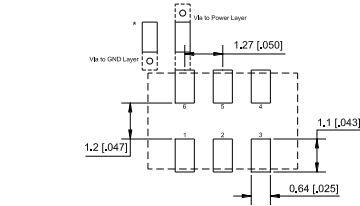
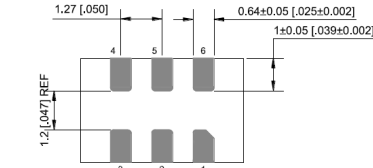

Recommended Land Pattern for LVPECL, LVDS, HCSL

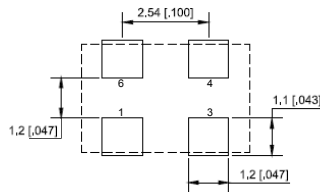

Recommended Land Pattern for CMOS

REFLOW PROFILE:

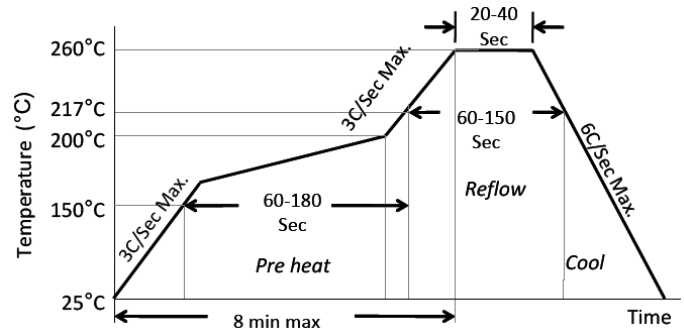

Ramp-Up Rate (200°C to Peak Temp)	3°C/Sec Max.
Preheat Time 150°C to 200°C	60-180 Sec
Time maintained above 217°C	60-150 Sec
Peak Temperature	255-260°C
Time within 5°C of actual Peak	20-40 Sec
Ramp-Down Rate	6°C/Sec Max.
Time 25°C to Peak Temperature	8 min Max.

TAPE AND REEL:

T= 1,000pcs/reel (D=180mm), T3= 3,000pcs/reel (D=330mm)

Tape 1

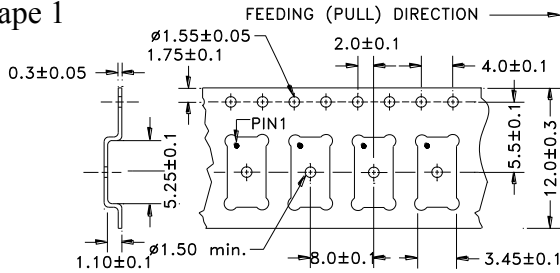

Tube: 72 pcs/tube

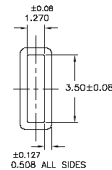

Unit orientation in tube:



Tape 2

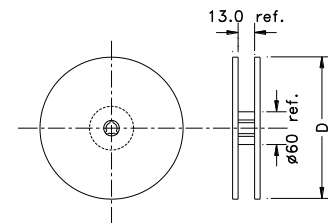
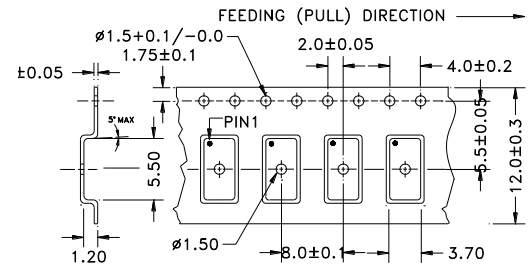

Dimensions: mm

ATTENTION: Abracon LLC's products are COTS – Commercial-Off-The-Shelf products; suitable for Commercial, Industrial and, where designated, Automotive Applications. Abracon's products are not specifically designed for Military, Aviation, Aerospace, Life-dependent Medical applications or any application requiring high reliability where component failure could result in loss of life and/or property. For applications requiring high reliability and/or presenting an extreme operating environment, written consent and authorization from Abracon LLC is required. Please contact Abracon LLC for more information.